

MEFA Trend - MEFA Parcel - MEFA Harmony - MEFA Classic MEFA Projects

Prijslijst Prix-courant

12 jaar garantie (2 jaar op Bosca 34, 408 en 418)
tegen doorroesten, indien correct onderhouden.
12 ans de garantie (2 ans sur Bosca 34, 408 et 418)
contre la perforation par la rouille, moyennant un entretien correct.



MEFA Trend



MEFA Harmony



MEFA Parcel



MEFA Classic



MEFA Projects



MEFA Fashion Colours





**MEFA Trend,
MEFA Harmony,
MEFA Classic,
Staanders/Supports**

MEFA Parcel







Keuze uit 66 RAL kleuren, zie brochure
Choix entre 66 couleurs RAL, voir brochure

	BTW/TVA excl.	BTW/TVA incl.
Netto meerprijs voor RAL kleur <u>per brievenbus</u>	74,38	90,00
Prix net pour supplément couleur RAL <u>par boîte aux lettres</u>		
Netto meerprijs voor RAL kleur <u>per set</u> van brievenbus en staander		
Prix net pour supplément couleur RAL <u>par set</u> de boîte aux lettres et support	136,36	165,00
Netto meerprijs voor RAL kleur <u>per pakjesbrievenbus</u>	148,76	180,00
Prix net pour supplément couleur RAL <u>par boîte aux lettres colli</u>		

MEFA Letter







Art. Nr. N° art.	Mod. Mod.	Materiaal en afmetingen (HxBxD) Matériau et dimensions (HxLxP)	RAL	Kleuren Couleurs	BTW/TVA excl.	EURO BTW/TVA incl.		
630 11205 630 11209 630 11201 630 11208 630 11203 630 11204 630 11206	MEFA 112 Letter 	Gegalvaniseerd staal 1mm Acier galvanisé 1mm	9005 7012 9010 7006 3009 1014 6005	zwart / noir basalt grijs / gris basalt puur wit / blanc pure beige grijs / gris beige oxide rood / rouge oxide ivoor / ivoire mosgroen / vert mousse	98,35 98,35 98,35 98,35 98,35 98,35 98,35	119,00 119,00 119,00 119,00 119,00 119,00 119,00		
630 11305 630 11309 630 11301 630 11308 630 11303 630 11304 630 11306		MEFA 113 Letter 	Gegalvaniseerd staal 1mm Acier galvanisé 1mm	9005 7012 9010 7006 3009 1014 6005	zwart / noir basalt grijs / gris basalt puur wit / blanc pure beige grijs / gris beige oxide rood / rouge oxide ivoor / ivoire mosgroen / vert mousse	123,14 123,14 123,14 123,14 123,14 123,14 123,14	149,00 149,00 149,00 149,00 149,00 149,00 149,00	
630 11105 630 11109 630 11101 630 11108 630 11103 630 11104 630 11106			Krantenrol Porte journaux 111 	Gegalvaniseerd staal 1mm Acier galvanisé 1mm	9005 7012 9010 7006 3009 1014 6005	zwart / noir basalt grijs / gris basalt puur wit / blanc pure beige grijs / gris beige oxide rood / rouge oxide ivoor / ivoire mosgroen / vert mousse	37,19 37,19 37,19 37,19 37,19 37,19 37,19	45,00 45,00 45,00 45,00 45,00 45,00 45,00

MEFA Trend

630 6501 630 6505 630 6509	MEFA 650 U:F:O 	Aluminium en gegalvaniseerd staal Aluminium et acier galvanisé	9016 9005 9006	wit / blanc zwart / noir zilver grijs / gris argent	263,64 263,64 263,64	319,00 319,00 319,00	
630 0651 630 0655 630 0659		Krantenrol Porte journaux 65 	Gegalvaniseerd staal Acier galvanisé	9016 9005 9006	wit / blanc zwart / noir zilver grijs / gris argent	35,12 35,12 35,12	42,50 42,50 42,50
630 6401 630 6405/s 630 6409			MEFA 640 Judo 	Gegalvaniseerd staal 1mm Acier galvanisé 1mm	9016 9005s 7036s	wit / blanc zwart struct./ noir struct. platina grijs str./ gris platino str.	271,90 271,90 271,90
630 3005 630 3001*	MEFA 300 Puffin 			roestvrij + gegalvaniseerd staal acier inoxydable + galvanisé	-- 9016	inox-zwart str. / inox-noir str. wit-zwart str. / blanc-noir str.	205,79 164,46
630 6305 630 6301 630 0630		MEFA 630 Wave 		Gegalvaniseerd staal 1,25mm Acier acier galvanisé 1,25mm	-- 9016 --	zwart-inox / noir-inox wit-inox / blanc-inox zwart-koper / noir-cuivre	230,58 230,58 296,69
630 3035 630 3031	MEFA 303 Penguin 		roestvrij + gegalvaniseerd staal, <u>met</u> kranten/pakjesvak acier inoxydable + galvanisé, <u>avec</u> porte journaux/colli	-- 9016	inox-zwart str. / inox-noir str. wit-zwart str. / blanc-noir str.	235,54 197,52	285,00 239,00
630 6320 630 6328 630 0632			MEFA 632 Journal 	Roestvrij staal 1,25mm, <u>met</u> kranten/pakjesvak Acier inoxydable 1,25mm, <u>avec</u> porte journaux/colli	INOX	full inox	379,34
	Roestvrij + gegalvaniseerd staal 1,25mm Acier inoxydable + acier galvanisé 1,25mm	--		inox-zwart / inox-noir	247,11	299,00	
	Koper + gegalvaniseerd staal 1,25mm Cuivre + acier galvanisé 1,25mm	--		koper-zwart / cuivre-noir	371,07	449,00	



MEFA Penguin & Journal:
met / avec
pakjesvak / compartiment colli



MEFA Harmony & Classic

630 4001 630 4005/s 630 4009 630 4000	MEFA 400 Amber 	Gegalvaniseerd staal 1mm Acier galvanisé 1mm	9016 9005s 7016 INOX	wit / blanc zwart struct./ noir struct. antraciet / anthracite geborsteld inox/inox brossé	263,64 263,64 263,64 409,09	319,00 319,00 319,00 495,00		
630 4011* 630 4015/s 630 4019		MEFA 401 Amber 	Gegalvaniseerd staal 1mm Acier galvanisé 1mm	9016 9005s 7016	wit / blanc zwart struct./ noir struct. antraciet / anthracite	288,43 288,43 288,43	349,00 349,00 349,00	
630 8251 630 8255/s			MEFA 825 Quartz 	Gegalvaniseerd staal 1,25mm Acier galvanisé 1,25mm	9016 9005s	wit / blanc zwart struct. / noir struct.	247,11 247,11	299,00 299,00
630 8308				MEFA 830 Columbus 	Warm gegalvaniseerd staal, <u>met</u> kranten/pakjesvak Acier galvanisé à chaud, <u>avec</u> porte journaux/colli	Galva	gegalvaniseerd/galvanisé	371,07
630 8440	MEFA 844 Topaz 	Roestvrij staal 1 mm, <u>met</u> krantenhouder Acier inoxydable 1 mm, <u>avec</u> porte journaux	INOX		geborsteld inox/inox brossé	271,90	329,00	
630 8728 630 8725/s 630 8729/s		MEFA 872 Pearl 	Gegalvaniseerd staal 1mm, <u>met</u> kranten/pakjesvak Acier galvanisé 1 mm, <u>avec</u> porte journaux/colli	9005s 9005s 7012s	zwart-inox klep/ noir-clapet inox zwart struct./ noir struct. grijs struct./gris struct.	197,52 164,46 164,46	239,00 199,00 199,00	
630 8705/s 630 8709/s	MEFA 870 Jade 		Gegalvaniseerd staal 0,7mm Acier galvanisé 0,7mm	9005s 7012s	zwart struct. / noir struct. grijs struct. / gris struct.	152,89 152,89	185,00 185,00	
630 8645/s 630 8649/s			MEFA 864 Ruby 	Gegalvaniseerd staal 0,7mm Acier galvanisé 0,7mm	9005s 7012s	zwart struct. / noir struct. grijs struct. / gris struct.	86,78 86,78	105,00 105,00
630 4609/s	MEFA 460 Fuga 	Gegalvaniseerd staal, alu klep Acier galvanisé, clapet en alu		7012s	grijs struct. / gris struct.	247,11	299,00	
630 3505/s 630 3509/s 630 3548		MEFA 350 Piano 	Gegalvaniseerd staal 0,7mm Acier galvanisé 0,7mm	9005s 7012s INOX	zwart struct./ noir struct. grijs struct./gris struct. geborsteld inox/inox brossé	106,61 106,61 180,99	129,00 129,00 219,00	
630 0995/s 630 0999/s 630 0990	MEFA 99 Minuet 		Roestvrij staal Acier inoxydable	9005s 7012s INOX	zwart struct./ noir struct. grijs struct./gris struct. geborsteld inox/inox brossé	57,81 57,81 111,57	69,95 69,95 135,00	
630 0911 630 0915			MEFA 34 Bosca 	Gegalvaniseerd staal 0,5mm Acier galvanisé 0,5mm	9016 9005	wit / blanc zwart/noir	48,76 48,76	59,00 59,00

MEFA Columbus & Pearl:
met / avec
pakjesvak / compartiment colli





MEFA Parcel

Art. Nr. N° art.	Mod. Mod.	Materiaal en afmetingen (HxBxD) Matériau et dimensions (HxLxP)	RAL	Kleuren Couleurs	BTW/TVA excl.	EURO BTW/TVA incl.
630 991 030	MEFA 991 Fuego 	Zonder naamplaatje - Sans plaque nominatif	9006	zilver grijs / gris argent	594,21	719,00
630 991 050		Deur vooraan - Porte devant	9002	grijs wit / gris blanc	594,21	719,00
630 991 060			7016	antraciet / anthracite	594,21	719,00
630 991 070		1094 x 511 x 390 mm 180,6 l	9005	zwart / noir	594,21	719,00
		gegalvaniseerd staal acier galvanisé				
630 991 031	MEFA 991 Fuego	Met naamplaatje - Avec plaque nominatif	9006	zilver grijs / gris argent	594,21	719,00
630 991 051		Deur vooraan - Porte devant	9002	grijs wit / gris blanc	594,21	719,00
630 991 061			7016	antraciet / anthracite	594,21	719,00
630 991 071		1094 x 511 x 390 mm 180,6 l	9005	zwart / noir	594,21	719,00
630 992 030	MEFA 992 Fuego	Zonder naamplaatje - Sans plaque nominatif	9006	zilver grijs / gris argent	701,65	849,00
630 992 050		Deur achteraan - Porte à l'arrière	9002	grijs wit / gris blanc	701,65	849,00
630 992 060			7016	antraciet / anthracite	701,65	849,00
630 992 070		1094 x 511 x 390 mm 180,6 l	9005	zwart / noir	701,65	849,00
630 992 031	MEFA 992 Fuego	Met naamplaatje - Avec plaque nominatif	9006	zilver grijs / gris argent	701,65	849,00
630 992 051		Deur achteraan - Porte à l'arrière	9002	grijs wit / gris blanc	701,65	849,00
630 992 061			7016	antraciet / anthracite	701,65	849,00
630 992 071		1094 x 511 x 390 mm 180,6 l	9005	zwart / noir	701,65	849,00
630 771 030	MEFA 771 Etna 	Zonder naamplaatje - Sans plaque nominatif	9006	zilver grijs / gris argent	495,04	599,00
630 771 050		Deur vooraan - Porte devant	9002	grijs wit / gris blanc	495,04	599,00
630 771 060			7016	antraciet / anthracite	495,04	599,00
630 771 070		1094 x 402 x 307 mm 110,7 l	9005	zwart / noir	495,04	599,00
		gegalvaniseerd staal acier galvanisé				
630 771 031	MEFA 771 Etna	Met naamplaatje - Avec plaque nominatif	9006	zilver grijs / gris argent	495,04	599,00
630 771 051		Deur vooraan - Porte devant	9002	grijs wit / gris blanc	495,04	599,00
630 771 061			7016	antraciet / anthracite	495,04	599,00
630 771 071		1094 x 402 x 307 mm 110,7 l	9005	zwart / noir	495,04	599,00
630 772 030	MEFA 772 Etna	Zonder naamplaatje - Sans plaque nominatif	9006	zilver grijs / gris argent	594,21	719,00
630 772 050		Deur achteraan - Porte à l'arrière	9002	grijs wit / gris blanc	594,21	719,00
630 772 060			7016	antraciet / anthracite	594,21	719,00
630 772 070		1094 x 402 x 307 mm 110,7 l	9005	zwart / noir	594,21	719,00
630 772 031	MEFA 772 Etna	Met naamplaatje - Avec plaque nominatif	9006	zilver grijs / gris argent	594,21	719,00
630 772 051		Deur achteraan - Porte à l'arrière	9002	grijs wit / gris blanc	594,21	719,00
630 772 061			7016	antraciet / anthracite	594,21	719,00
630 772 071		1094 x 402 x 307 mm 110,7 l	9005	zwart / noir	594,21	719,00

630 483 011	MEFA 483 Balsa 	Pakjesbus zonder brievenbus	9010	puur wit / blanc pure	276,86	335,00
630 483 021		Boîte aux colli sans boîte aux lettres	7012	basalt grijs / gris basalt	304,96	369,00
630 483 031			7021	antraciet / anthracite	304,96	369,00
630 483 041		1030 x 410 x 310 mm	9006	zilver grijs/gris alu	304,96	369,00
		gegalvaniseerd staal acier galvanisé				
630 483 111	MEFA 483 Balsa	Pakjesbus met 1 brievenbus	9010	puur wit / blanc pure	346,28	419,00
630 483 121		Boîte aux colli avec 1 boîte aux lettres	7012	basalt grijs / gris basalt	346,28	419,00
630 483 131			7021	antraciet / anthracite	346,28	419,00
630 483 141		1030 x 410 x 310 mm	9006	zilver grijs/gris alu	346,28	419,00
630 483 211	MEFA 483 Balsa 	Pakjesbus met 2 brievenbussen	9010	puur wit / blanc pure	404,13	489,00
630 483 221		Boîte aux colli avec 2 boîte aux lettres	7012	basalt grijs / gris basalt	404,13	489,00
630 483 231			7021	antraciet / anthracite	404,13	489,00
630 483 241		1030 x 410 x 310 mm	9006	zilver grijs/gris alu	404,13	489,00

630 4595	MEFA 459 Mega 	Gegalvaniseerd staal Acier galvanisé 1202 x 528 x 442 mm 96 l	9005sm	zwart semi mat/noir semi mat	594,21	719,00
630 4805/s 630 4809/s 630 4808	MEFA 480 Oak 	MULTIBOX gegalvaniseerd staal 1mm MULTIBOX acier galvanisé 1mm Deur vooraan - Porte devant 1010 x 421 x 344 mm 127 l	9005s 7012s 7016	zwart struct./noir struct. grijs struct./gris struct. antraciet / anthracite	412,40 412,40 412,40	499,00 499,00 499,00
630 4815/s 630 4819/s 630 4818	MEFA 481 Oak 	MULTIBOX gegalvaniseerd staal 1mm MULTIBOX acier galvanisé 1mm Deur achteraan - Porte à l'arrière 1010 x 421 x 344 mm 127 l	9005s 7012s 7016	zwart struct./noir struct. grijs struct./gris struct. antraciet / anthracite	428,93 428,93 428,93	519,00 519,00 519,00
630 4579 630 4571 630 4575 630 4578	MEFA 457 Beech 	Gegalvaniseerd staal 1mm Acier galvanisé 1mm Deur vooraan - Porte devant 1021 x 409 x 326 mm 102 l	9006 9016 9005 7016	zilver grijs/gris alu wit / blanc zwart / noir antraciet / anthracite	329,75 329,75 329,75 329,75	399,00 399,00 399,00 399,00
630 4589 630 4581 630 4585 630 4588	MEFA 458 Beech 	Gegalvaniseerd staal 1mm Acier galvanisé 1mm Deur achteraan - Porte à l'arrière 1021 x 409 x 326 mm 102 l	9006 9016 9005 7016	zilver grijs/gris alu wit / blanc zwart / noir antraciet / anthracite	346,28 346,28 346,28 346,28	419,00 419,00 419,00 419,00
630 4855/s 630 4859/s	MEFA 485 Pine 	Gegalvaniseerd staal 1mm Acier galvanisé 1mm 1110 x 430 x 305 mm 95 l	9005s 7012s	zwart struct./noir struct. grijs struct./gris struct.	296,69 296,69	359,00 359,00
630 4775/s 630 4771 630 4778	MEFA 477 Hazel 	Gegalvaniseerd staal 1mm Acier galvanisé 1mm Deur vooraan - Porte devant 1043 x 385 x 230 mm 95 l	9005s 9016 7016	zwart struct./noir struct. wit / blanc antraciet / anthracite	247,11 247,11 247,11	299,00 299,00 299,00
630 4785/s 630 4788	MEFA 478 Hazel 	Gegalvaniseerd staal 1mm Acier galvanisé 1mm Deur achteraan - Porte à l'arrière 1043 x 385 x 230 mm 95 l	9005s 7016	zwart struct./noir struct. antraciet / anthracite	268,60 268,60	325,00 325,00
630 4085/s	MEFA 408 Bosca 	Gegalvaniseerd staal 1mm Acier galvanisé 1mm Deur vooraan - Porte devant 1050 x 385 x 245 mm 83 l	9005s	zwart struct./noir struct.	197,52	239,00
630 4188 630 4181	MEFA 418 Bosca 	Gegalvaniseerd staal 1mm Acier galvanisé 1mm Deur achteraan - Porte à l'arrière 1050 x 385 x 245 mm 83 l	7016 9016	antraciet / anthracite wit / blanc	214,05 214,05	259,00 259,00
630 4955/s 630 4959/s	MEFA 495 Magnum 	Aluminium 2 mm Aluminium, 2 mm 520 x 450 x 285 mm 53 l	9005s 7012s	zwart struct./noir struct. grijs struct./gris struct.	329,75 329,75	399,00 399,00

Staanders / Supports

Art. Nr. N° art.	Mod. Mod.	Materiaal Matériau	RAL	Kleuren Couleurs	BTW/TVA excl.	EURO BTW/TVA incl
631 0213 631 0219/s	 21	Staal gegalvaniseerd met 2 beugels Acier galvanisé avec 2 crochets	-- 7012s	gegalvaniseerd / galvanisé grijs struct. / gris struct.	37,19 37,19	45,00 45,00
631 0221 631 0225/s 631 0229/s 631 02208 631 02201 631 02203 631 02204 631 02206 631 0228 631 0220	 22	Staal gegalvaniseerd en verlakt Acier galvanisé et laqué	9016 9005s 7012s 7006 9010 3009 1014 6005 -- INOX	wit / blanc zwart struct. / noir struct. grijs struct. / gris struct. beige grijs / gris beige puur wit / blanc pure oxide rood / rouge oxide ivoor / ivoire mosgroen / vert mousse gegalvaniseerd / galvanisé geborsteld inox/inox brossé	81,82 81,82 81,82 81,82 81,82 81,82 81,82 81,82 81,82 78,51 144,63	99,00 99,00 99,00 99,00 99,00 99,00 99,00 99,00 99,00 95,00 175,00
631 0281 631 0285/s 631 0280	 28	Staal verzinkt en verlakt Acier zinqué et laqué	9016 9005s INOX	wit / blanc zwart struct. / noir struct. geborsteld inox/inox brossé	106,61 106,61 202,48	129,00 129,00 245,00
631 0635/s 631 0638	 063	Vlakke staander met lamp en naamplaatje Support plat avec lampe et plaq. nominative	9005s INOX	zwart struct. / noir struct. geborsteld inox/inox brossé	400,83 487,60	485,00 590,00
631 0725/s 631 0729/s 631 0721 631 0725 631 0729 631 0720	 72	Staal verzinkt en verlakt Acier zinqué et laqué	9005s 7012s 9016 9005 9006 INOX	zwart struct. / noir struct. grijs struct. / gris struct. wit / blanc zwart / noir zilver grijs / gris argent geborsteld inox/inox brossé	103,31 103,31 103,31 103,31 103,31 173,55	125,00 125,00 125,00 125,00 125,00 210,00
631 0838	Columbus 83	Warmgegalvaniseerd / Galvanisé à chaud	Galva	gegalvaniseerd / galvanisé	189,26	229,00
631 0010	Easy-Mounting	Snel systeem om eenvoudig staanders te monteren zonder beton of stabilisé Système facile pour le montage rapide des supports sans utiliser du béton ou du stabilisé			57,02	69,00
630 0391 630 0395 630 0399	35	Muurbevestigingsplaat Plaque de montage mural	9016 9005 9006	wit / blanc zwart / noir zilver grijs / gris argent	35,12 35,12 35,12	42,50 42,50 42,50

Sloten / Serrures

630 A20000	MEFA veiligheidsslot + 2 sleutels / Serrure MEFA + 2 clés (kam links/battant gauche)	28,93	35,00
630 A21000	MEFA veiligheidsslot + 2 sleutels / Serrure MEFA + 2 clés (kam vertikaal/battant verticale)	28,93	35,00
630 0380	RUKO slot + 2 sleutels / RUKO serrure + 2 clés	48,76	59,00
630 0382	SL klein slot + 2 sleutels / SL serrure petit + 2 clés	15,70	19,00
630 0384	Euro-lock groot / Euro-lock grand (mod. 495, 630, 705)	17,77	21,50
630 0386	Handle: Handgreep slot / Serrure poignée (mod. 485, 457, 490)	28,93	35,00

MEFA Projecten - Projets

Gemeenschappelijke brievenbussen – Boîtes aux lettres communes

MEFA Oslo 784

Ondiepe brievenbus, maximum 4 eenheden boven elkaar

Boîte aux lettres étroites, maximum 4 unités en hauteur

materiaal : gegalvaniseerd staal, klep in aluminium

matériau : acier galvanisé, clapet en aluminium

H/H 286 (+ 26) x B/L 449 x D/P 162 mm

Prijs per eenheid/Prix par unité

Excl.	Incl. BTW/TVA
€ 214,05	€ 259,00

Uitvoering in inox/version inox

Excl.	Incl. BTW/TVA
€ 342,98	€ 415,00

MODEL784

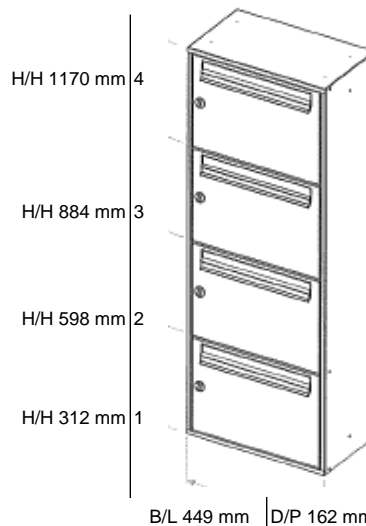

MEFA Copenhagen 701- Cardiff 702

Rechtsdraaiende deur

Porte tournante à droite

materiaal : gegalvaniseerd staal, klep in aluminium

matériau : acier galvanisé, clapet en aluminium

701 : H/H 157 (+ 28) x B/L 407 x D/P 300 mm

702 : H/H 157 (+ 28) x B/L 316 x D/P 400 mm

Prijs per eenheid/Prix par unité

Excl.	Incl. BTW/TVA
€ 177,69	€ 215,00

Uitvoering in inox/version inox

Excl.	Incl. BTW/TVA
€ 276,86	€ 335,00

MODEL701

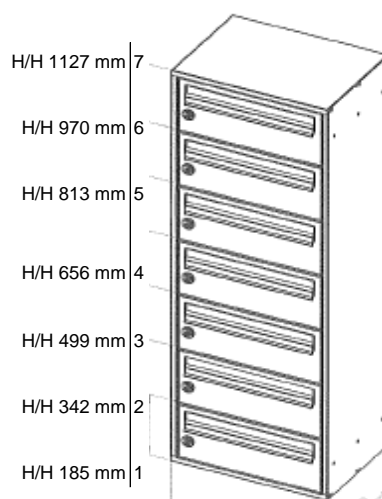

MEFA London 700 - Lyon 750

Neervallende deur

Porte battante

materiaal : gegalvaniseerd staal, front en klep in aluminium

matériau : acier galvanisé, front et clapet en aluminium

700 : H/H 160 (+ 16) x B/L 407 x D/P 300 mm

750 : H/H 160 (+ 16) x B/L 316 x D/P 400 mm

Prijs per eenheid/Prix par unité

Excl.	Incl. BTW/TVA
€ 177,69	€ 215,00

MODEL750

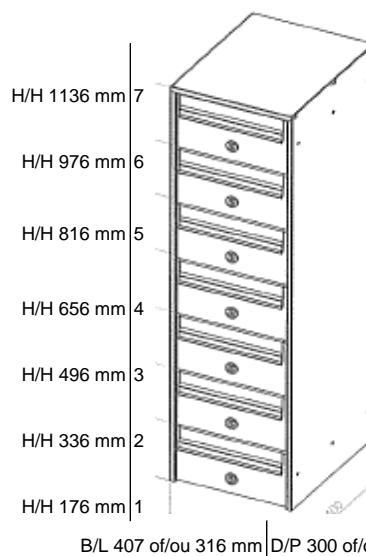

MEFA Projecten - Projets

Gemeenschappelijke brievenbussen – Boîtes aux lettres communes

MEFA Paris 720 - Palermo 770

Deuropening achteraan

Porte à l'arrière

materiaal : gegalvaniseerd staal, front en klep in aluminium

matériau : acier galvanisé, front et clapet en aluminium

720 : H/H 157 (+ 29) x B/L 407 x D/P 300 mm

770 : H/H 157 (+29) x B/L 316 x D/P 400 mm

Prijs per eenheid/Prix par unité

Excl.	Incl. BTW/TVA
€ 235,54	€ 285,00

MODEL720

H/H 1128 mm 7

H/H 971 mm 6

H/H 814 mm 5

H/H 657 mm 4

H/H 500 mm 3

H/H 343 mm 2

H/H 186 mm 1

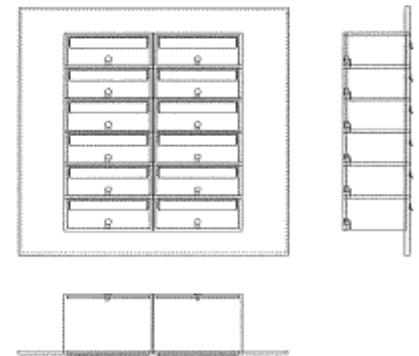

B/L 407 of/ou 316 mm | D/P 300 of/ou 400 mm

PALEN + STEUNBALKEN (niet voor 784)

PILIEREN + TRAVERS (pas pour 784)

		Gegalvaniseerd staal Acier galvanisé		Geborsteld inox Inox brossé	
		Excl.	Incl. BTW/TVA	Excl.	Incl. BTW/TVA
070090	Set van 2 palen / Set de 2 piliers voor montage in grond / montage dans le sol	€ 309,92	€ 375,00	€ 495,04	€ 599,00
		2000 mm			
070091	Set van 2 palen / Set de 2 piliers voor montage op vloer / montage sur le sol	€ 409,09	€ 495,00	€ 511,57	€ 619,00
		1200-1700 mm			
	Steunbalk per kolom / Travers par colonne (min. 2)	€ 86,78	€ 105,00	€ 144,63	€ 175,00

DAKEN (niet voor 784)

TOITURES (pas pour 784)

	Gegalvaniseerd staal Acier galvanisé		Geborsteld inox Inox brossé	
	Excl.	Incl. BTW/TVA	Excl.	Incl. BTW/TVA
Dak per kolom / Toiture par colonne	€ 103,31	€ 125,00	€ 164,46	€ 199,00

STANDAARD KLEUREN

COULEURS STANDARD

RAL 9005 gitzwart / noir profond

RAL 7016 antraciet / anthracite

RAL 9006 zilvergrijs / gris alu

RAL 9016 signaalwit / blanc signal

~**RAL 9005S** zwart structuur / noir structure

~**RAL 7012S** grijs structuur / gris structure

Supplement alu fronten gelakt in een standaard kleur Supplément fronts en alu lacqué dans une couleur standard	per front/par front	Excl. € 28,10	Incl. BTW/TVA € 34,00
---	---------------------	---------------	-----------------------

+

Supplement alu kleppen gelakt in een standaard kleur Supplément clapets en alu lacqué dans une couleur standard	per klep/par clapet	€ 16,53	€ 20,00
--	---------------------	---------	---------

Niet standaard kleuren
Couleurs non standard

Prijs op aanvraag
Prix sur demande

Leveringstermijn MEFA Projecten : 5 à 8 weken

Délai de livraison MEFA Projets : 5 à 8 semaines